

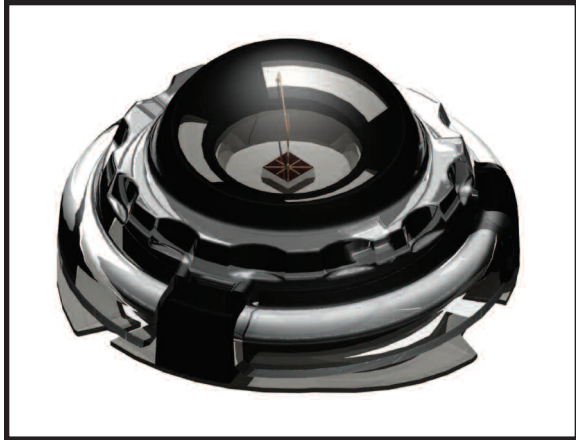

...the power is in the package



9900-1201-32

White Power LED

Screw thread design

Lambertian radiation pattern



Typical Device Characteristics @ 350mA

Luminous Flux	52 lumens
Dominant Wavelength	5500 K
Forward Voltage	3.50 V
Viewing Angle	110°

Product Features

- Solder-Free mechanical attachment for easy installation and replacement
- Annular contact arrangement eliminates need for radial alignment
- Excellent thermal coupling to lighting system
- Large LED chip allows high drive current
- Outstanding light output
- Wide viewing angle
- UV resistant cover lens
- RoHS Compliant

Device Characteristics

Forward Current = 350mA, Junction Temperature, $T_j = 25^\circ\text{C}$

	Minimum	Typical	Maximum
Luminous Flux (ϕ_v)		52 lm	
Dominant Wavelength (λ_D)	4500 K	5500 K	10000 K
Peak Wavelength (λ_p)		x=0.33, y=0.33	
Spectral Half-Width ($\Delta\lambda^{1/2}$)		70	
Viewing Angle ($2\theta^{1/2}$)		110°	
Forward Voltage (V_F)	3.00 V	3.50 V	4.10 V
Dynamic Resistance (R_D)		1.3 Ω	
Thermal Resistance ($R\theta_{j-c}$)		10°C/W	

Absolute Maximum Ratings

DC Forward Current	350 mA
Peak Pulsed Forward Current	500 A
Maximum Pulse Duty Cycle	50%
Maximum Pulse Duration	10 ms
Reverse Voltage	> 5 V
LED Junction Temperature	125°C
Operating Temperature Range	-40°C to +85°C
Storage Temperature Range	-40°C to +100°C

Mechanical Dimensions

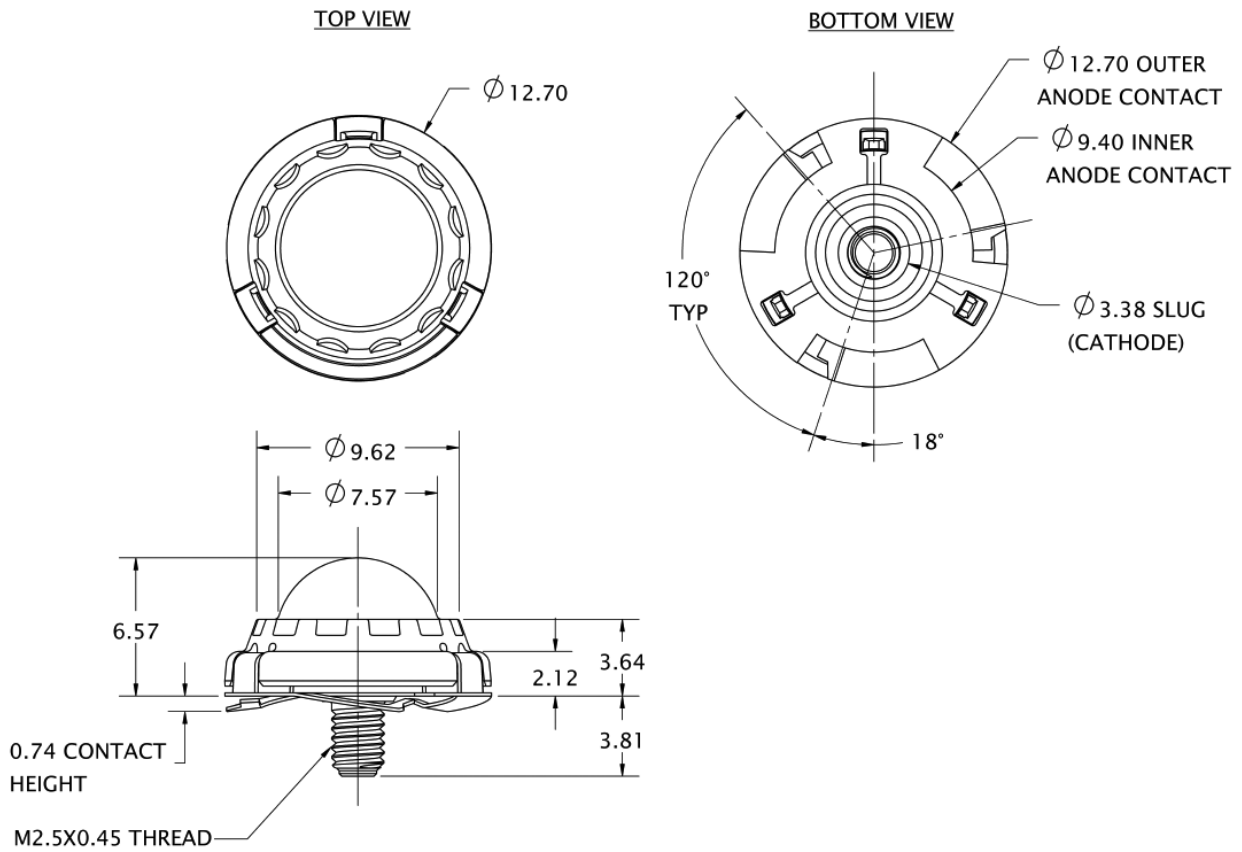

Spatial Distribution Pattern

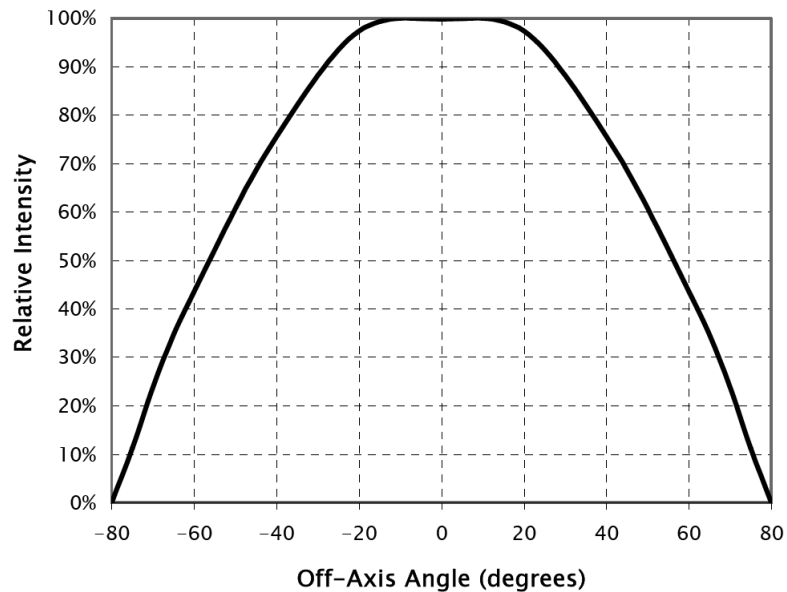

Spectral Power Distribution

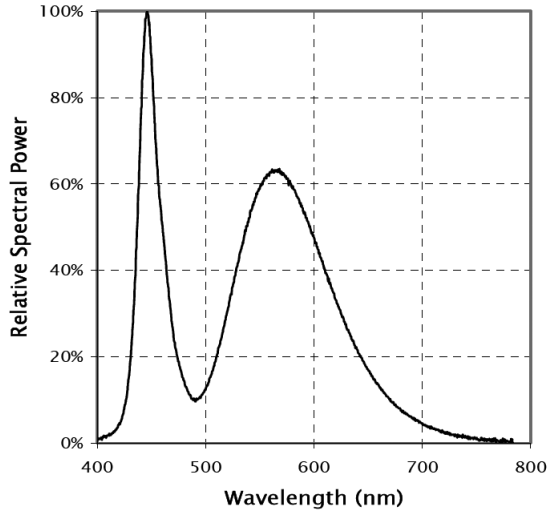

Wavelength vs. Forward Current

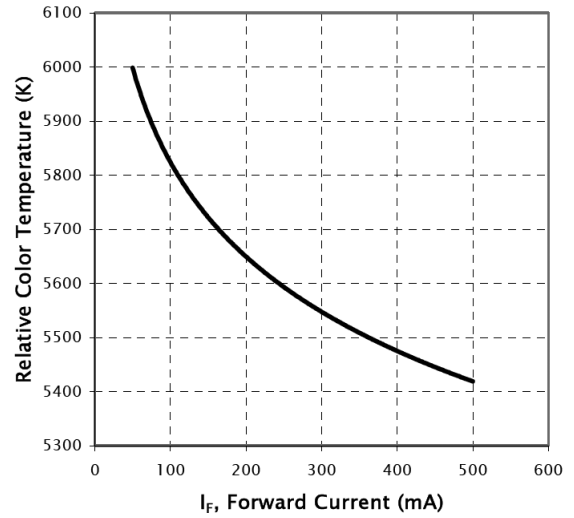

Forward Voltage vs. Forward Current

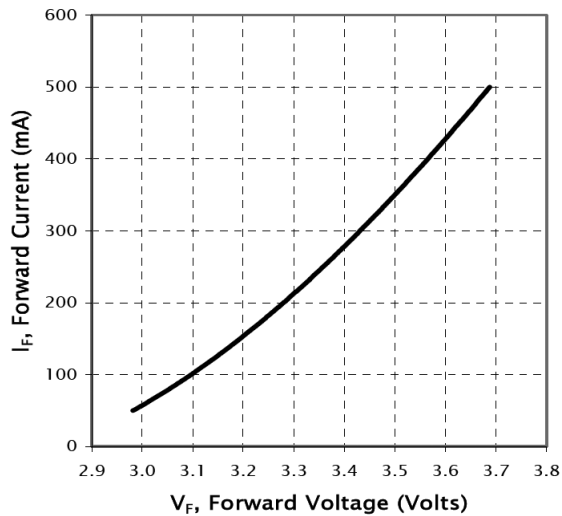

Luminous Flux vs. Forward Current

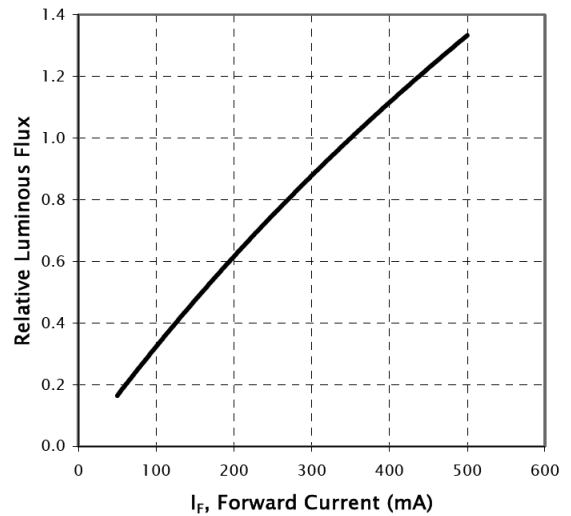

A product of Weldon | 3656 Paragon Drive | Columbus, Ohio 43228 USA
 800.989.2718 | 614.529.7230 | FAX 614.527.3547 | <http://www.v-led.com>

Weldon Technologies reserves the right to make changes at any time to product specifications without notice.